

USER MANUAL

WI-FI THERMOSTAT

ATB100



ENGLISH REV 1.5

Termoregolatori Campini - Corel SpA
Via Don Guanella 1, 22066 Mariano Comense (CO) ITALY



Index

Warning.....	2
Product description	2
Shipping contents.....	2
Compatibility.....	3
Supported installations	3
Campini Thermostat.....	4
Campini Router.....	6
App	6
Inserting / replacing batteries	7
Configuration.....	8
Campini thermostat does not communicate correctly	10
Router Campini does not communicate correctly	11
Operating mode.....	12
Heating prediction	13
Hysteresis (ON / OFF) / Advanced (PID) Adjustment	13
Energy efficiency class (ErP)	13
Support	14
Technical specifications	14
Declaration conformity UE.....	15

Warning

- Read the instructions before installing and using this product.
- The product should not be used with different functions other than those described below.
- **Attention:** before separating the Campini Thermostat from the relative plate fixed to the wall, remove the electric current from the system.
- For the use of the product it is necessary to have a WIFI network.
- For the use of the product it is necessary to have a smartphone or Tablet with internet connection.
- Install the Router Campini within the range of domestic WIFI network.
- The maximum reception distance between Campini Router and Campini Thermostat in open air is about 100 meters; obstacles between Router and thermostat, as walls, reduce the receiving distance.

Product description

With the Campini Thermostat it is possible to manage your heating and cooling system from your smartphone and tablet.

Thanks to the electronic ink display, the Campini Thermostat can operate for a period of about 1 year with the same batteries, the autonomy depends on the type of operation and the parameters set. To preserve battery consumption, the update of the room temperature, shown on the display, is performed if the variation detected is at least 0.2 ° C.

If your house has a multi-zone system, you can install more Campini Thermostats, up to a maximum of 8, and associate them with the same Campini Router.

Through the *Campini Corel Thermostat* application, it is possible to associate several Campini Routers to the same account. Consequently it is possible to control multiple systems with the same user.

Shipping contents

1 Campini Thermostat

1 Campini Router

3 AAA batteries 1.5V

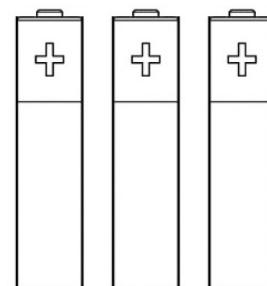
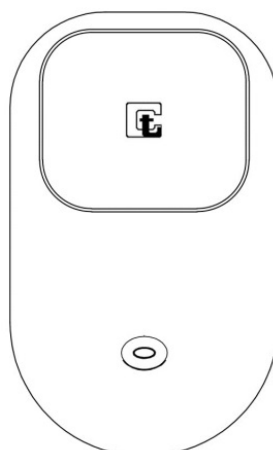
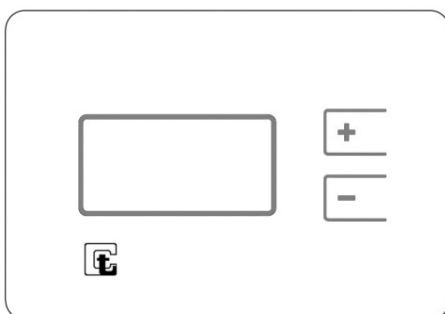

Compatibility

The Campini Thermostat has a relay in voltage-free deviation and can be used with low and high voltages, which makes the device compatible with the majority of heating and cooling. The wiring diagram, placed on the plate of the thermostat, indicates how to connect the control cables. The following list contains the types of supported systems:

- Gas burner
- Fan coil unit
- Zone valve
- Electric heater
- Radiant or floor plant
- Cooling system

Supported installations

In a single zone installation, the Campini Thermostat directly controls the system via the control cables. It communicates via radio with the Campini Router which is connected via a WI-FI network to the internet thus allowing remote control thanks to the *Campini Corel Thermostat* application.

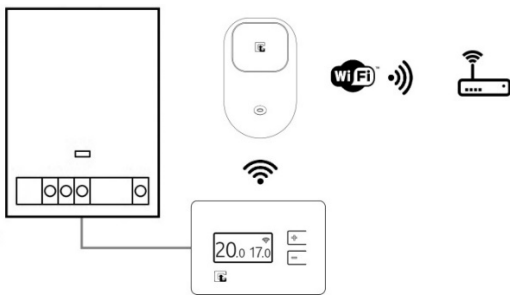

If your house has a multi-zone system, you can install more Campini Thermostats, up to a maximum of 8, and associate them with the same Campini Router. With this configuration, with the Campini Thermostats connected to the zone valves, it is possible to remotely control the individual zones.

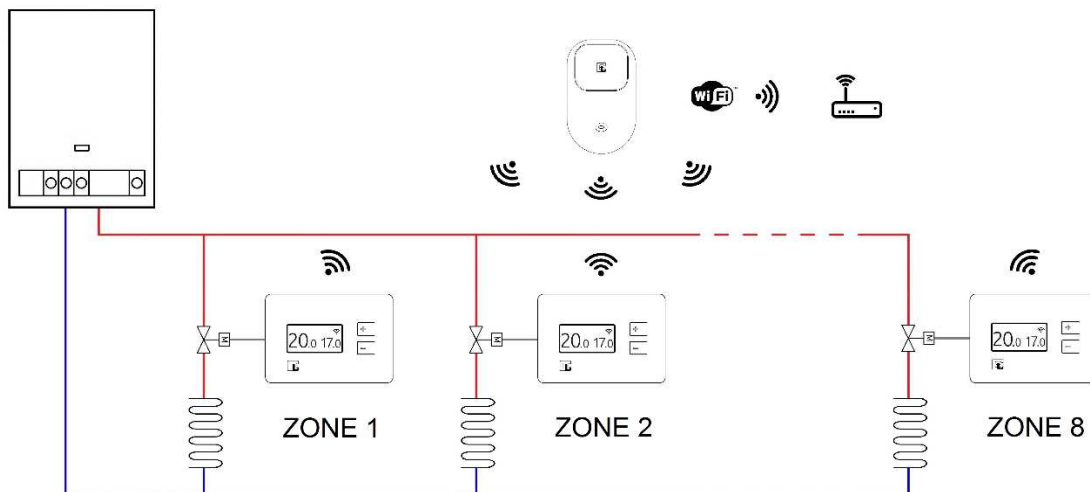

Campini Thermostat

With this display you can view some of the key information on the status of the Campini Thermostat operation:

- Detected temperature and setpoint temperature, respectively on the left and right of the display.



- The icon representing the radio connection status between Campini Thermostat and Campini Router is located at the top right.



- If the heating mode is active, when the system is turned on, the display shows the icon  .



- If conditioning mode is active, when the system is turned on, the display shows the icon  .



- If the automatic weekly program mode is active, no icon appears on the display.



- If the Campini Thermostat is in manual mode, the display shows the icon  .



- If the Campini Thermostat is in Away mode, the display shows the icon  .



- If the Campini Thermostat is in antifreeze mode, the display shows the icon  .



The Campini Thermostat has two buttons to perform the following actions:

- Modify the setpoint temperature by activating the manual mode for a pre-set time period that can be modified through the application.
- Start the association process between the Campini Thermostat and the Campini Router (press the 2 buttons simultaneously for 3 seconds).
- Turn off and turn off the Campini Thermostat (press the 2 buttons simultaneously and release them).

Campini Router

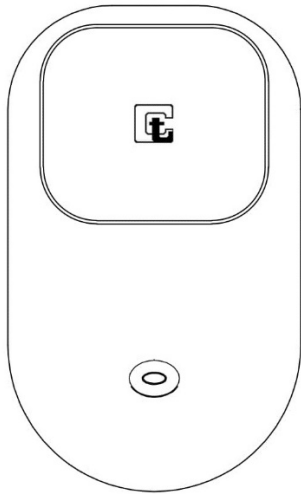

Using the button you can do one of the following operations (See chapter **Configuration**):

- Start the pairing process between Campini Router and WIFI network.
- Start the pairing process between Campini Thermostat and Campini Router.

By means of light signals, you can view information about the setup or the status of the Campini Router:

- The continuous flashing of red light indicates the start of the process of association between the Campini Thermostat and Campini Router.
- A fast blinking of red light indicates to send a data packet to Campini Thermostat.
- Three quick flashes of blue light followed by a pause indicates that the Campini Router is ready to be associated with the WIFI network.
- The slow flashing of the blue light with one-second cycles indicates the attempt to connect to the WIFI network.
- A rapid flashing of the blue light followed by a pause of about 4 seconds indicates the correct connection with the WIFI network.

App

The application is a necessary tool to manage the thermostat and Campini Router.

In addition to the management of the operating mode and of the weekly program, it is possible to display graphics with the temperature trend with the relative setpoint and monthly consumption.



With push and via email notifications, you can receive information on the status of the product, for example, the need to replace batteries of the Campini Thermostat. The application is available free on Play Store (Android 4.2 and higher) and App Store (iOS 9 and later).

For more information visit the website **atb100.campinicare.it**.

Inserting / replacing batteries

The replacement of the Campini Thermostat batteries must be performed when the icon  appears on the display and on the application. The user will also be notified with push notifications and, if enabled, notifications via email.



The first icon () indicates that the batteries are low and must be replaced, the second icon () indicates that the batteries are exhausted and the thermostat is no longer in operation.

Attention: before separating the Campini Thermostat from the relative plate fixed to the wall, remove the electric current from the system.

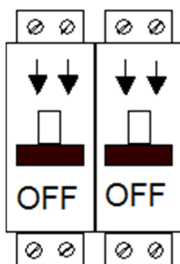

To separate the Campini Thermostat from the relative plate fixed to the wall, it is sufficient to insert a suitable tool into the slot located on the right side of the Campini Thermostat and exert a slight pressure until the front part of the device separates from the plate.

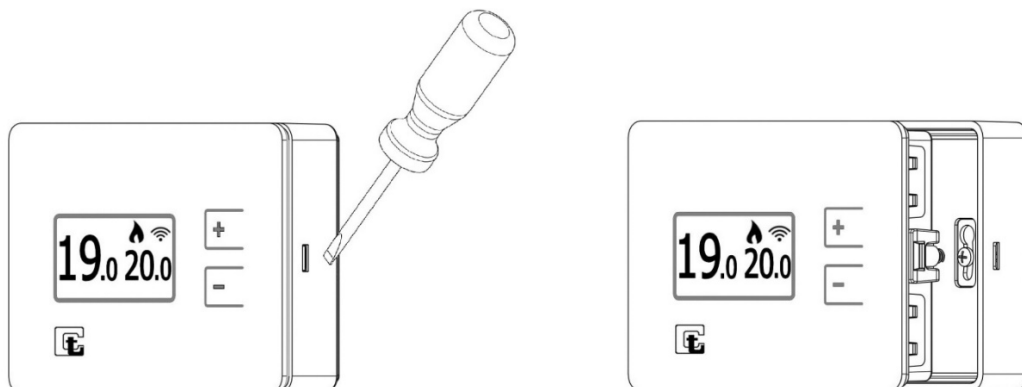

Warning: if the metal contacts in the battery compartment are dirty, they must be cleaned. At this point it is sufficient to replace the three AAA batteries respecting the polarity, insert the Campini Thermostat in the plate fixed to the wall and restore the electric current of the system.

Configuration

The list below shows step by step how to install and activate the Campini Thermostat and Router:

- 1) Download the Campini application available for Android and IOS operating systems which can be downloaded in their stores.
- 2) Open the APP and create an account.
- 3) Confirm your account using the email sent by Termoregolatori Campini - Corel S.p.A. to the email address indicated in the account's creation.
- 4) Ensure that your mobile device is connected to the WIFI network that you want to set in the Campini Router.
- 5) Log in to the *Campini Corel Thermostat* application.
- 6) Press "COMBINE A CAMPINI ROUTER" or, alternatively, go to the page "Accommodations" in the application and press "+".
- 7) Connect the Campini Router to an electric socket while pressing the button for at least 2 seconds (continuous quick blinking of the blue light followed by a pause).

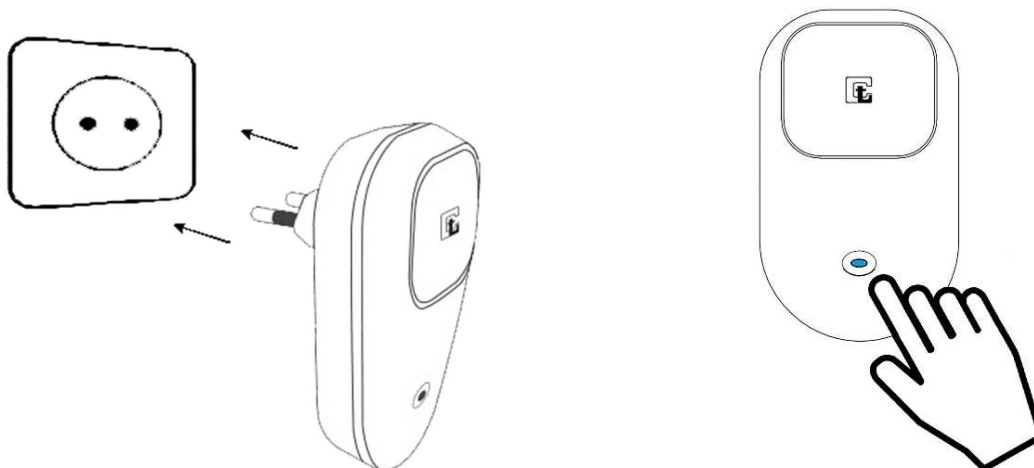

- 8) Connect your mobile device to the Wi-Fi network created by the Campini Router (SSID: CCCT).



- 9) Enter SSID and password of domestic Wi-Fi in the appropriate fields.
- 10) Click "CONNECT TO THE ROUTER"
- 11) Wait for your mobile device to be connected with internet.
- 12) Click "CONFIRM".
- 13) Enter information regarding accommodations in the provided fields.

14) Click "CONFIRM".

Before proceeding, it is advisable to check the correct connection of the Campini Router to the home WIFI network. Wait at least for one minute and observe the blue light propagated by the button:

- The slow flashing of the blue light with one-second cycles indicates the attempt to connect to the WIFI network. If the type of luminous signaling does not change, see the chapter **Router Campini does not communicate correctly**.
- A rapid flashing of the blue light followed by a pause of about 4 seconds indicates the correct connection with the WIFI network. Go to the next step.

15) Press and hold the two buttons on the Campini Thermostat until its code is shown and then press for at least 2 seconds the Campini Router button (flashing red) to pair the two devices.

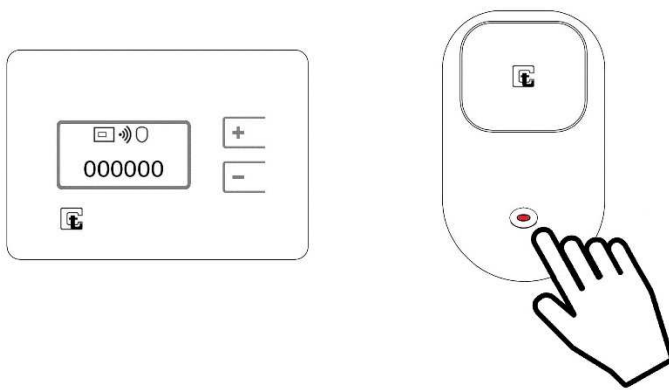

At the end of the association of the 2 devices, the Campini Thermostat display returns

to normal display and the symbol . If this symbol does not appear, the Campini Thermostat is too far from the Campini Router, or there is an obstacle, such as thick walls or shielding materials, between them. In this case it is necessary to bring the Campini Router closer to the Campini Thermostat and repeat point 15

Press the icon  on the *Campini Corel Thermostat* application to display, in the list proposed, the new Campini Thermostat associated. If the application does not show the newly paired device, press the icon again until it appears.

16) Remove the protective film placed on the front part of the Campini Thermostat.

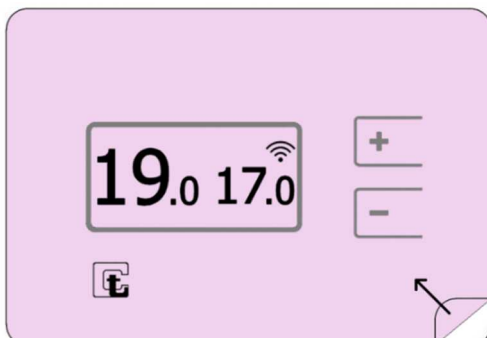

Campini thermostat does not communicate correctly



If the icon  appears on the Campini Thermostat, this means that communication with the Campini Router is not available



This icon, if rarely observed, does not constitute a functional problem for the device. The most likely cause is the energy saving system which tends to dampen the power of the radio signal. In complete autonomy the Campini Thermostat will increase the radio signal strength to re-establish the radio transmission.

If the icon  is displayed often, the causes can be multiple:

- 1) The Campini Thermostat or the Campini Router have recently been moved. In this case the radio communication can be interrupted for a few minutes due to the energy saving system. If the problem is temporary it is not necessary to intervene.
- 2) The Campini Thermostat is too far from the Campini Router, or there is an obstacle, such as thick walls or shielding materials, between them. In this case it is necessary to bring the Campini Router closer to the Campini Thermostat.
- 3) The Campini Thermostat has been eliminated using the *Campini Corel Thermostat* application.
- 4) The Campini Router is turned off.

If the icon  or icon  does not appear on the Campini Thermostat, this means that the association with the Campini Router has not been performed (see the **Configuration** chapter).

Router Campini does not communicate correctly

Through the light signals emitted by the Campini Router it is possible to know its operating status. Therefore to intervene in case of malfunctions it is sufficient to observe these luminous signals.

- The red light signals indicate the correct radio communication between Campini Thermostat and Campini Router. If you observe the system is working properly.
- Three quick flashes of blue light followed by a pause indicates that the Campini Router is ready to be associated with the WIFI network and, therefore, to your Campini Corel Thermostat account. If the **Configuration** procedure is not in progress, it is sufficient to switch the Campini Router off and on again to exit this procedure.
- The slow flashing of the blue light with one-second cycles indicates the attempt to connect to the WIFI network. Once powered, the Campini Router will try to connect to the Wi-fi network set during the **Configuration** procedure. If this warning persists, it means that the device cannot connect to the WIFI network.

The causes can be:

- 1) The password entered during the **Configuration** procedure is incorrect.
- 2) The SSID inserted during the **Configuration** procedure is incorrect.
- 3) The WIFI access point is turned off.

To resolve causes 1 and 2, it is sufficient to carry out the **Configuration** procedure again. Cause 3 can be solved by turning on the access point or, alternatively, repeat the **Configuration** procedure and associate the Campini Router with another WIFI access point.

If a WIFI network is not available, the Campini Thermostat and the Campini Router will continue to operate according to the last parameters set via the *Campini Corel Thermostat* application.

- A rapid flashing of the blue light followed by a pause of about 4 seconds indicates the correct connection with the WIFI network, therefore the Campini Router is working correctly. If, despite this indication, it is impossible to manage the product using the *Campini Corel Thermostat* application, carry out the following checks:
 - 1) Check if the access point is connected to an internet line
 - 2) Check if the WIFI access point does not limit communications with some devices. This case can occur if the Campini Router is connected to corporate networks or networks equipped with MAC filters.

Operating mode through the application (App)

The desired temperature (set point) can be set using one of the following modes:

- Automatic:  the setpoint is automatically changed according to the weekly program set by the application.



- Manual:  You can select a set point to be maintained for a period of time same as the selected one, or always active.



- Absent:  You can select a set point that is kept until the date and selected time, or always active.



- Antifreeze:  the setpoint is set to 5°C until the date and selected time, or always active.



When one of the Manual, Absent and Antifreeze mode ends, the Campini Thermostat automatically returns to the Automatic weekly program mode.

Heating prediction

According to the weather conditions and the characteristics of the house, the Campini Thermostat is able to turn on the heating in advance to reach the desired temperature at the programmed time. Alternatively, you can use the parameter "Minutes in advance for each ° C" which is a value fixed in advance; you have to put the minutes required to get the variation of a degree of temperature with heating system on active mode. You can also adjust viewing the graph with the trend of the ambient temperature.

You can also set the advanced fixed value to 0, but in this case you will not be able to receive notifications of any system abnormalities.

Hysteresis (ON / OFF) / Advanced (PID) Adjustment

The Campini Thermostat can take advantage of two different algorithms to adjust the temperature: hysteresis or advanced adjustment.

When the Campini Thermostat is turned on the first time, it is set with hysteresis adjustment suitable to any type of system. For systems in which the temperature change is faster, by setting the advanced adjustment you obtain a slowdown of the temperature rise near the setpoint set such as to reduce the over temperature and obtain an energy saving with a more stable temperature control.

Before activating the advanced adjustment, you also need to consider that the Campini Thermostat must acquire the thermal inertia of your home and your heating system so to manage the "Advanced heating prediction" mode, and therefore it is recommended the hysteresis adjustment for at least the first two weeks of operation of the Campini Thermostat with active heating system.

The following table can be used to figure out what the ideal setting for your home is:

	Hysteresis	Advanced
With the heating always on, how much does the temperature increase in an hour?	<3 ° C	> 3 ° C
Is it compatible with a heat pump?	YES	NO
Is it compatible with a wood boiler?	YES	NO

Energy efficiency class (ErP)

Supplier name or trademark: Temperature Campini - Corel SpA

Vendor identifier model: ATB100

Class of temperature control: IV

Contribution of temperature control of Energy Efficiency: 2%

Support

If necessary, you can consult the Internet address atb100.campinicores.it.

If you cannot find a solution to your problem, you can contact the technical assistance by writing an email to the email address support@campinicores.it.

Technical specifications

CAMPINI THERMOSTAT

- Power supply: 3 AAA alkaline batteries (LR03), Duration: about 1 year
- Size: 115x80x27 mm
- Temperature measurable: from 0 ° C to 50 ° C (Resolution: ± 0.1 ° C)
- Setting temperature: 5 ° C to 35 ° C (Resolution: ± 0.1 ° C)
- Maximum switching current: 8 A
- Maximum switching voltage: 250 Vac / 30 Vdc
- Operating temperature: from 0 to 40 ° C
- Relative Humidity: Max 85% (non-condensing)
- Transport temperature: from -10 to 50°C
- Protection Degree: IP20
- RF connection: 868 MHz
- Control cables: maximum \varnothing 1.5mm
- Type of action: 1B
- Degree of pollution: 2
- Pulse voltage: 4000V
- Software: Class A
- Electrical insulation: Class II

CAMPINI ROUTER

- Power supply: 100-240VAC 50 / 60Hz
- Power consumption: 45mA Max
- Size: 103x62x60 mm
- Operating temperature: from 0 to 60 ° C
- Relative Humidity: Max 85% (non-condensing)
- Transport temperature: from -10 to 60 ° C
- Protection Degree: IP40
- WI-FI: IEEE 802.11 b / g / n 2.4 GHz
- RF Connection: 868 MHz
- Type of action: 1B
- Degree of pollution: 2
- Pulse voltage: 4000V
- Software: Class A
- Electrical insulation: Class II

Declaration conformity UE

The manufacturer, Termoregolatori Campini-Corel Spa, declares that the ATB100 radio equipment device complies with the 2014/53/EU Directive.

The complete text of the Eu declaration of conformity is available at the following Internet address: atb100.campinicarel.it/UE.pdf.



The WEEE symbol means that according to local laws and regulations your product and / or its battery should be recycled separately from household waste. When the product becomes unusable, take it to a collection point designated by local authorities. The separate collection and recycling of your product and / or its battery at the time of disposal will help conserve natural resources and ensure that recycling takes place in respect of human health and the environment.